



## The Effect of Ozonation Process on Bromide-Containing Groundwaters in Bandung Area and Its Surroundings

Mindriany Syafila, Sukandar & Eric Haryanto

Faculty of Civil and Environmental Engineering, Institut Teknologi Bandung  
Jalan Ganesha 10 Bandung, Jawa Barat 40132, Indonesia  
Email: mindri@ftsl.itb.ac.id

**Abstract.** Disinfection process was applied as the last step of the water treatment to kill pathogenic bacteria in the water. However, according to several studies, the ozonation disinfection process could form undesired by-products. One of the by-products potentially affecting human life is bromate produced from bromide ionic-containing water. This study was carried out to examine the effect of raw water characteristics and pH on bromate formation. Also, the performance of bromate formation for a period of exposure time was analyzed. Raw waters taken from four different areas around Bandung were exposed to ozone introduced to a reactor with a flow rate of 2 L/min. The pH of the raw waters varied from 4, 7 to 10. The results show that there was no evidence of an initial bromide ion concentration, whereas a change in pH value gives a significantly different outcome. In acidic condition (pH of 4) the bromate formation tends to decrease, whereas when the pH value increases to a pH of 10, the bromate formation increases. Therefore, for drinking water with a neutral pH, when bromide ions are detected in the raw water, the drinking water may be toxic due to the presence of bromate.

**Keywords:** *bromate; disinfection; groundwater; ozonation; pH.*

### 1 Introduction

Drinking water is very important for human life. The daily need for drinking water per person varies from 2.1 liter to 2.8 liter, depending on weight and activity. Most of this drinking water is supplied by local authorities through treated-water supply systems. However, the quantity and quality of the drinking water produced cannot fulfill the demand. Therefore, some private companies produce bottled water. Since some of those private companies are home industries, they obtain the groundwater from locally, ranging from fresh environments to densely populated areas. In the Bandung area, the Tangkubanperahu area is an example of a fresh environment, while Ciumbuleuit is an example of a densely populated area. The groundwater characteristics of these areas could be affected by the activities that take place in those areas. For

example, a public transportation station is located at Ledeng, and a traditional market can be found in Lembang.

Most private companies use surface water treatment to produce bottled drinking water. A disinfection process is applied as the last step of the treatment to kill pathogenic bacteria contained in the water. Ozonation is one of the most-used disinfection techniques worldwide [1]. It is believed that the ozonation technique is more efficient than other disinfection techniques [2].

Ozone ( $O_3$ ) is a strong oxidator that can rapidly react with microorganisms and organic substances contained in water, so its action as a disinfectant is stronger than chlorine compounds [2]. Therefore, ozone is an excellent disinfectant for inactivating undesired pathogens. Furthermore, it can also be used to deactivate some viral and protozoa pathogens [2,3].

Ozone can also remove odor and taste as well as toxic compounds and micropollutants. However, according to several studies, the disinfection process by ozonation can form undesired by-products because of the high ozone exposure necessary for inactivating the microorganisms [2]. The disinfection by-products can be classified in three categories, i.e. non-brominated organic compounds, brominated organic compounds, and halogenates [4].

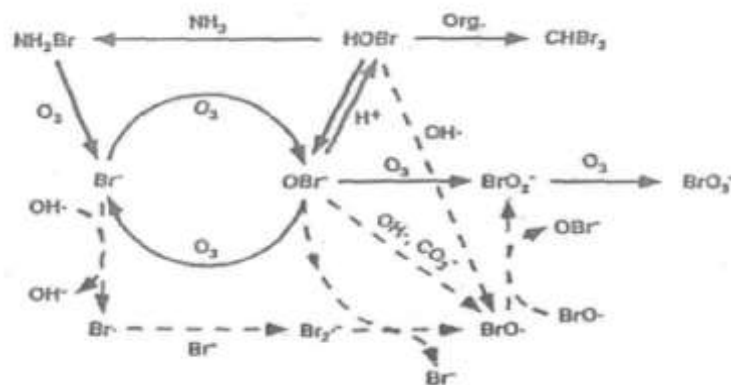

**Figure 1** Bromate formation mechanism [5].

One of the undesired disinfection by-products affecting human life is bromate produced in bromide ions-containing water. Bromate formation includes reactions with molecular ozone and with  $OH$  radicals, which is a complicated mechanism [4]. The key reactions of bromate formation are shown in Figure 1. The oxidation of bromide to hypobromous acid ( $HOBr$ ) is influenced by the presence of ozone, while further oxidations take place mostly through  $OH$  radicals. The formation of bromate compounds raises the particular problem

that they cannot be further removed biologically after the disinfection process [2].

Bromate is a genotoxic human carcinogen [6]. This bromate compound can cause loss of hearing, and decline of kidney and intestinal functions [7]. Delker, *et al.* [8] also mention the kidney as the major target organ for bromate as well as other effects such as peritoneal and follicular thyroid cancer. Therefore, the characteristics of raw water in relation to bromate formation should be considered.

Several studies have been carried out to analyze the effects of different water quality parameters on bromate formation. One of the results showed that bromate formation could be caused by an increased bromide concentration [9, 10]. Moreover, the bromate concentration increases as the ozone dose increases. Therefore, the ozone dose and also the ozone residual play an important role in bromate formation [10].

Besides the ozone dose, bromate formation could also be affected by the presence of hydroxyl radicals, as mentioned above [4,11]. In this case, the higher the amount of hydroxyl radicals present, the higher the bromate formation will be [12]. In the bromate formation mechanism, hydroxyl radicals form hypobromite radicals in bromide ions-containing water. The hypobromite radical is unstable and easily degrades to hypobromite and bromite, which will then oxidize to form bromate. Figure 1 can be expressed as the following equations [13]:



These equations show that bromide will be oxidized by ozone to form bromate with the intermediate product of hypobromite. The ozone present will not oxidize hypobromous acid to bromate. The hypobromous acid will be formed under acid conditions and it is suggested that the formation of bromate could be minimized at low pH levels. Therefore, pH is another factor affecting bromate formation in bromide-containing waters [4,10,14].

## 2 Materials and Methods

The experiments for this research were carried out at the Water Treatment Engineering Laboratory at the Faculty of Civil and Environmental Engineering, Institut Teknologi Bandung. A reactor with a diameter of 15 cm and a volume of 7 liter was used as a contactor between the ozone and the raw water. An ozone generator (Sanyo ACS-PRF1) linked to an aerator was used to produce the ozone introduced to the reactor. A schematic diagram of the apparatus is shown in Figure 2. Raw water with a flow rate of 2 L/min was exposed to the ozone.

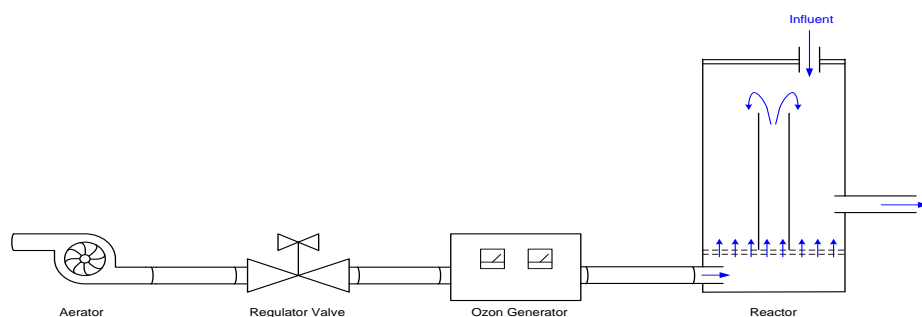

**Figure 2** Schematic diagram of the ozonation process reactor.

The ozonation experiment was carried out under batch conditions. The ground waters were taken from four different areas, i.e. the residential area of Ciumbuleuit, the public transportation station area of Ledeng, the traditional market area of Lembang and the rural area of Tangkubanperahu. The maximum contact time of the disinfection process was 60 minutes, and the first contact was measured after 3 minutes of exposure. The ozone dose applied for the groundwater ozonation processes was calculated by multiplying the flow rate with the contact time applied. Three different pH values of raw water were applied, 4, 7 and 10, respectively.

The parameters analyzed in this work include pH value, bromate concentration and remaining ozone concentration. The pH was detected using a pH meter (Orion SN5732). Prior to the pH measurement, Standard Method 4500-H<sup>+</sup>B [15] calibrations of the probe were conducted using buffered solutions at a pH of 4, 7, and 10.

The remaining dissolved ozone was measured using an indigo colorimetric method based on the Standard Method 4500-O<sub>3</sub> Indigo Colorimetric Method [15]. The samples were analyzed using a Spectronic 20 Genesys spectrophotometer at a wavelength of 600 nm. Since the upper limit of this

method is 2.5 mg/L, diluted samples were used to determine the higher ozone concentrations.

Bromate concentrations were analyzed using a spectrophotometer (Spectronic 20 Genesys) with a wavelength of 530 nm, based on the Standard Method 4500-Br<sup>-</sup> Phenol Red Colorimetric Method [15].

### 3 Results and Discussion

#### 3.1 Raw Water Characteristics and Bromate Formation

Raw waters were taken from four different areas surrounding Bandung, i.e. groundwater from Ciumbuleuit, Ledeng, Lembang and Tangkubanperahu. The characteristics of the raw waters were examined, including the following parameters: pH, temperature, bromide concentration, chloride concentration, manganese and ferri concentration as well as turbidity and alkalinity, as shown in Table 1.

**Table 1** The characteristics of raw water samples used.

Parameter	Ciumbuleuit groundwater	Ledeng groundwater	Lembang groundwater	Tangkubanperahu groundwater
pH	7.03	6.82	6.87	7.26
Temperature (°C)	25.4	23.5	23.2	20.8
Chloride (mg/L)	22.60	4.52	26.12	21.60
Manganese (mg/L)	0	0	0	0
Fe <sup>2+</sup> (mg/L)	0.143	0.046	0.035	0.088
Turbidity (NTU)	1	1	1	1
Ammonia (as mg/L NH <sub>4</sub> <sup>+</sup> )	0	0	0	0
Ion bromide (mg/L)	0.33	0.2	0.6	0.4
Bromate (ug/L)	0	0	0	0

The above table shows that the pH values of all raw waters display a neutral condition. However, the bromide concentrations were slightly different in each case. The highest bromide concentration was found in the Lembang groundwater sample. All of the groundwater samples were exposed to ozone with similar initial doses.

#### 3.2 Bromate Formation as a Function of Ph Value for All Raw Waters

One of the affecting factors in bromate formation is the pH value. In this work the pH of the raw waters used was altered to achieve an acidic condition (pH 4), a neutral condition (pH 7) and a base condition (pH 10). Figure 3 shows the

remaining ozone concentration at certain time intervals during the 60-minute ozonation process. It seems that after 15 minutes of exposure, the remaining ozone concentration remained constant in all raw waters used. This means that a longer time exposure would not increase the remaining ozone concentration.

During the ozonation process under the acidic condition there was evidence that no bromate was formed. The lack of bromate formation might due to the change of the initial bromide ions into hypobromous acid (HOBr). Under acidic conditions the equilibrium tends to produce more hypobromous acid. Therefore, it seems that the concentration of this acid would increase, which could prevent the formation of bromate [5].

Based on the results of the acidic-condition experiment, it seems that the initial bromide ion concentration was not the determining factor. However, the pH value has an important role since the pH under an acidic condition (in this case pH 4) could prevent bromate formation.

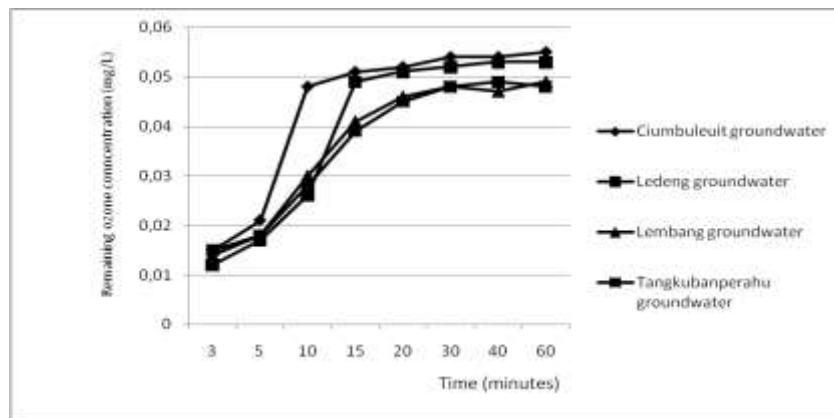
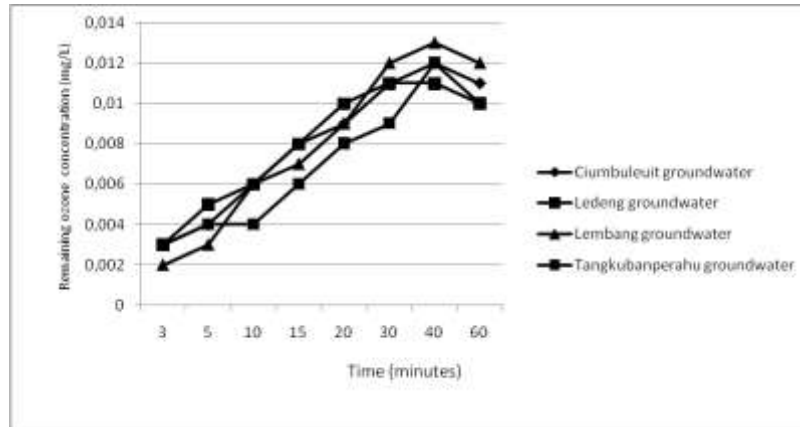

**Figure 3** The remaining ozone concentration during the ozonation process at pH 4.

As the pH value was increased to achieve the normal condition (a pH of 7), the longer the exposure time the higher the remaining ozone concentration in the reactor, as shown in Figure 4. It seems that the high ozone concentration could lead to bromate formation, as shown in Figure 5.

At the beginning of the experiment, there was still no bromate formation. However, after 15 minutes of exposure the bromate formation tended to be constant, which is supported by another research, that shows that the optimum contact time for ozonation is in the range of 5-15 minutes [2]. This means that a longer exposure time would not produce more bromate but it would increase the

remaining ozone concentration. This result differs from that of Kalmaz, *et al.* [16] where a higher ozone concentration gave a higher bromate formation. Therefore, it could be concluded that at a normal pH of 7 after 15 minutes of exposure there is no correlation between the remaining ozone concentration and the bromate formation.



**Figure 4** The remaining ozone concentration during ozonation at pH 7.

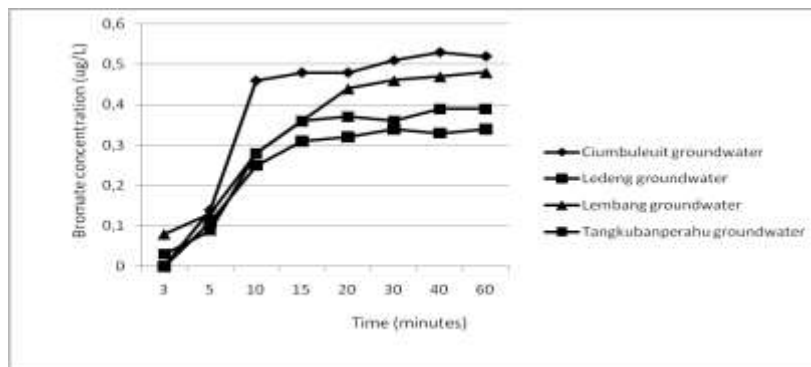

**Figure 5** The bromate concentration during ozonation at pH 7.

According to the bromate formation mechanism shown in Figure 1, ionic bromide will expose the ozone to catalytic decomposition to form hypobromite as an intermediate product. The further reaction of hypobromite with the remaining ozone produces bromite, which easily oxidizes to form bromate. The predominant species formed at a higher pH value was hypobromite. At a lower pH value it seems that the formation of hypobromous acid might be taken place. Since this acid would not react with ozone, bromate formation could be minimized.

The results of this experiment show that at a base pH (= 10) the remaining ozone concentration seems to be smaller than at a lower pH value (Figure 6). Hence, the bromate formation tends to increase, as shown in Figure 7. Due to more hydroxyl radicals, it might be formed at a higher pH value [16].

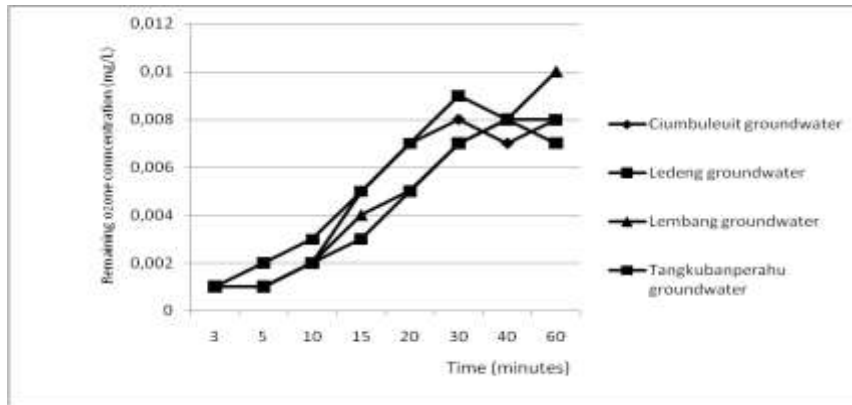

**Figure 6** The remaining ozone concentration during ozonation at pH 10.

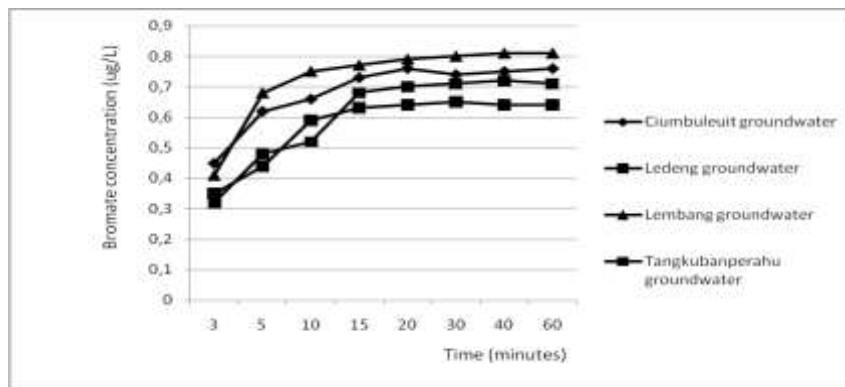

**Figure 7** The bromate concentration during ozonation at pH 10.

From the above explanation it seems that in applying ozonation in a disinfection process, the optimum ozone dose should be determined, being the dose applied for removing most bacterial pathogens without any bromate formation occurring. Furthermore, if the raw waters have a neutral pH and also contain bromide, a preliminary process for decreasing the pH value has to be applied prior to the disinfection process in order to minimize bromate formation. Some technologies can be considered, such as using a magnetic ion exchange resin [17], adsorption by silica zeolites [18], or using cerium dioxide during the ozonation process [19]). Post treatment of the disinfection process could also be



considered since there is a possibility of bromate being formed, as mentioned by Marhaba and Bengraïne [20].

### 3.3 Bromate Formation Kinetics

The ozonation performance as a function of ozonation contact time was analyzed for each raw water, which led to bromate formation kinetics. Figure 8 shows the relationship between the bromate concentration formed and the exposure time of the ozonation process related to the characteristics of the Ciumbuleuit, Ledeng, Lembang, and Tangkubanperahu groundwaters, respectively.

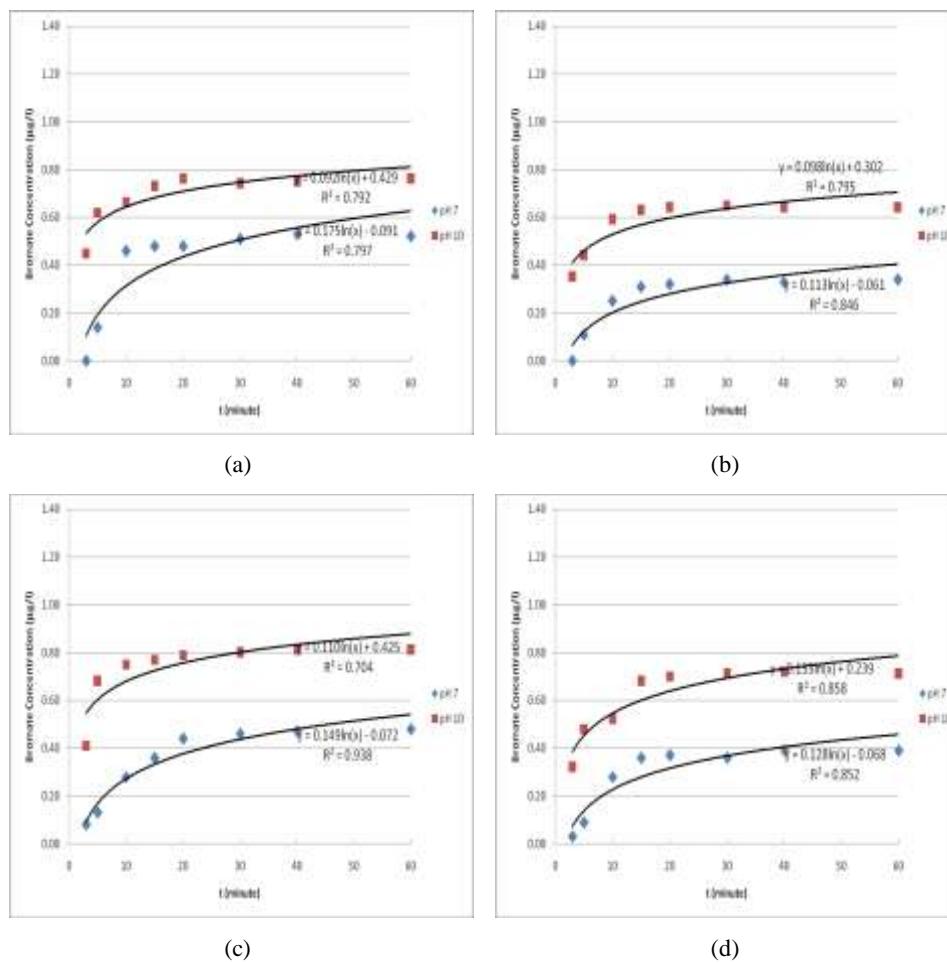

**Figure 8** Bromate formation kinetics during ozonation applied to groundwater from: a) Ciumbuleuit, b) Ledeng, c) Lembang, and d) Tangkubanperahu.

Figure 8 shows that a determination factor of 0.80 was achieved for all groundwaters at any pH level. This means that there was a strong relationship between time of exposure and bromate concentration formation. At the earlier exposure time of up to 20 minutes, the increase in bromate concentration was in a logarithmic phase, whereas after an exposure time of 20 up to 60 minutes the bromate concentration tended to be constant. The above figure shows that the bromate formation rate seems to be similar. It could be concluded that there would be an optimum contact time for bromate formation, where the longer the contact time applied the less significant the amount of bromate produced. The same phenomenon was also obtained with the raw waters with a pH of 7 and of 10, respectively.

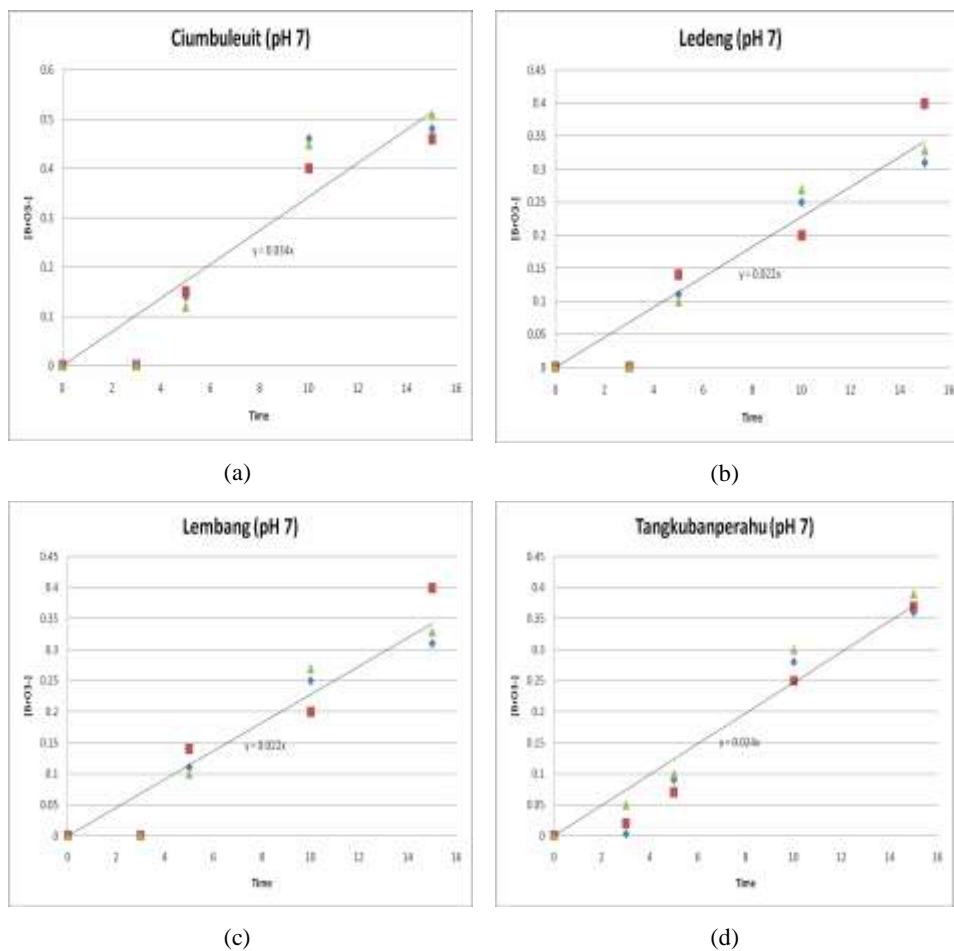

**Figure 9** The bromate formation rate as a function of contact time at pH 7.

The rate of bromate produced can be determined as a function of the bromide concentration, whereas the overall reaction based on Eqs. (1)–(4) [13] would be:

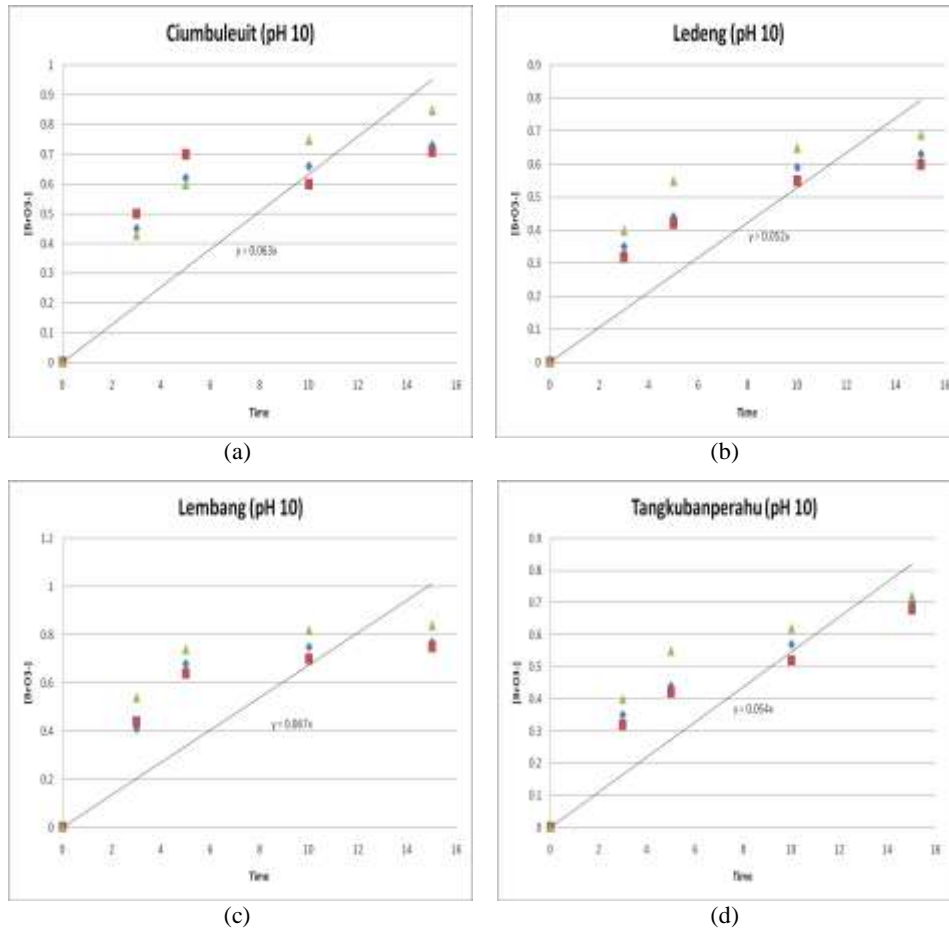
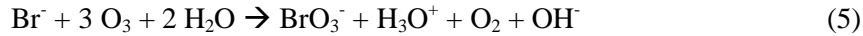

**Figure 10** The bromate formation rate as a function of contact time at pH 10.

Therefore, it is assumed that the reaction would be first order. However, since bromate might be the end product of the ozonation process of bromide-containing raw water, the bromate formation rate could be determined as being zero order, where the reaction rate would be expressed as (in molar basis):

$$d[\text{BrO}_3^-] / dt = k \quad (6)$$

with boundary conditions of at  $t = 0$ , then  $[\text{BrO}_3^-] = [\text{BrO}_3^-]_0$ , and at  $t = t$ , then  $[\text{BrO}_3^-] = [\text{BrO}_3^-]$ , the equations can be written as:

$$[\text{BrO}_3^-]_t = kt + [\text{BrO}_3^-]_0 \quad (7)$$

If at  $t = 0$ ,  $[\text{BrO}_3^-]_0 = 0$ , then the equations can be written as:

$$[\text{BrO}_3^-] = kt \quad (8)$$

A plot of  $[\text{BrO}_3^-]$  versus  $t$  will yield a line with a slope equal to positive  $k$ .

From Eq. (8), the relationship between the bromate formation rate and the contact time can be plotted as in Figure 9 for pH 7 and Figure 10 for pH 10, where the slope is equal to positive  $k$ .

Figure 9 shows that the bromate formation rate at pH 7 seems to be not significantly different for all raw waters, with a range of 0.022–0.034  $\mu\text{g/L/minute}$ . This phenomenon also occurred at pH 10 (see Figure 10) with the bromate formation rate ranging from 0.052 up to 0.067  $\mu\text{g/L/minute}$ . However, it seems that the bromate formation rate at pH 10 was higher than at pH 7. Therefore, the ozonation process has to be carefully applied for groundwater or water resources with a pH of 10 since the amount of bromate produced would be higher compared to acidic and neutral water resources. Hence, since the quality standard for drinking water requires a neutral pH, the bromate formation rate should be considered if bromide-containing raw water is used as a water supply source.

#### 4 Conclusions

The pH value plays an important role, since the pH under an acidic condition (in this case pH 4) could prevent bromate formation. It could be concluded that with a normal pH of 7 after 15 minutes of exposure there was no correlation between the remaining ozone concentration and bromate formation. The higher the pH value, the more bromate formation in bromide-containing raw water occurs if ozonation is applied as a disinfection process. Since the pH value of drinking water should be neutral, it seems we ought to know the raw water characteristics. If the raw water tends to contain bromide it could become carcinogenic when the ozonation disinfection process is applied. Therefore, if the ozonation process will be applied to bromide-containing water at a neutral pH, it seems other processes should be considered as preliminary treatment, as well as post-treatment of the ozonation process.

#### References

- [1] Montgomery, J.M., *Water Treatment: Principles and Design*, A Wiley Interscience Pub., 1985.

- [2] Von Gunten, U., *Ozonation of Drinking Water: Part II. Disinfection and By-Product Formation in Presence of Bromide, Iodide, Chlorine*, Water Research, **37**, pp. 1469-1487, 2003.
- [3] Von Gunten, U., Driedger, A., Gallard, H. & Salhi, E., *Rapid Communication By-Products Formation During Drinking Water Disinfection: A Tool to Assess Disinfection Efficiency?*, Water Research, **35**(8), pp. 2095-2099, 2001.
- [4] Von Gunten, U. & Pinkernell, U., *Ozonation of Bromide-Containing Drinking Waters: A Delicate Balance between Disinfection and Bromate Formation*, Water Science and Technology, **41**, pp. 53-69, 2000.
- [5] Von Gunten, U. & Hoigne, J., *Bromate Formation During Ozonation-Containing Water*, Proc. 11<sup>th</sup> Ozone World Congress, Int. Ozone Assoc., S942-S949, 1993.
- [6] Aljundi, I.H., *Bromate Formation during Ozonation of Drinking Water: A Response Surface Methodology Study*, Desalination, **277**(1-3), pp. 24-28, 2011.
- [7] Kruihof, J.C., *Disinfection by-product Formation*, NV PWN Water Supply Co., 2002.
- [8] Delker, D., Hatch, H., Allen, J., Crissman, B., George, M., Geter, D., Kilburn, S., Moore, T., Nelson, G., Roop, B., Slade, R., Swank, A., Ward, W. & DeAngeol, A., *Molecular Biomarkers of Oxidative Stress Associated with Bromate Carcinogenicity*, Toxicology, **221**, pp. 158-165, 2006.
- [9] Song, R.P., Westerhoff, P., Minear, R. & Amy, G., *Bromate Minimization During Ozonation*, J. American Water Works Assoc., **89**, pp. 69-78, 1997.
- [10] Peldszus, S., Andrews, S.A., Souza, R., Smith, F., Douglas, I., Bolton, J. & Huck, P.M., *Effect of Medium-Pressure UV Irradiation on Bromated Concentrations in Drinking Water, A Pilot-Scale Study*, Water Research, **38**, pp. 211-217, 2004.
- [11] Haag, W.R. & Hoigne, J., *Ozonation of Bromide-Containing Water: Kinetic of Formation of Hypobromous Acid and Bromate*, Environmental Science and Technology, **17**, pp. 261-267, 1983.
- [12] Westerhoff, P., Amy, G., Song, R. & Minear, R., *Simplifying Bromate Formation Kinetics Analysis with A Linear Bromate Yield Concept*, ACS Books, pp. 322-349, 1996.
- [13] Kumar, A., Rout, S. & Singhal, R.K., *Health Risk Assessment for Bromate ( $BrO_3^-$ ) Traces in Ozonated Indian Bottled Water*, Journal of Environmental Protection, **2**, pp. 571-580, 2011.
- [14] Legube, B., Parinet, B., Gelinet, K., Berne, F. & Croue, J.-P., *Modeling of Bromate Formation by Ozonation of Surface Waters in Drinking Water Treatment*, Water Research, **38**(8), pp. 2185-2195, 2004.

- [15] Eaton, A.D., Clesceri, L.S. & Greenberg, A.E. (eds), *Standard Methods for the Examination of Water and Wastewater*, American Public Health Association, 21<sup>st</sup> Edition, Washington D.C., 2005.
- [16] Kalmaz, E.E., Eraslan, A.H. & Kim, A.H., *A Preliminary Kinetics Model Predicting Concentration Variations of Hypobromous Acid and Bromated In Ozonated Marine Water*, *Ecological Modeling*, **29**, pp. 315-326, 1985.
- [17] Johnson, C.J. & Singer, P.C., *Impact of A Magnetic Ion Exchange Resin on Ozone Demand and Bromate Formation During Drinking Water Treatment*, *Water Research*, **38**(17), pp. 3738-3750, 2004.
- [18] Sagehashi, M., Shiraishi, K., Fujita, H., Fujii, T. & Sakoda, A., *Ozone Decomposition of 2-Methylisoborneol (MIB) in Adsorption Phase on High Silica Zeolites with Preventing Bromate Formation*, *Water Research*, **39**(13), pp. 2926-2934, 2005.
- [19] Zhang, T., Chen, W., Ma, J. & Qiang, Z., *Minimizing Bromated Formation with Cerium Dioxide During Ozonation of Bromide-Containing Water*, *Water Research*, **42**(14), pp. 3651-3658, 2008.
- [20] Marhaba, T.F. & Bengraine, K., *Review Strategies for Minimizing Bromate Formation Resulting from Drinking Water Ozonation*, *Engineering Clean Technologies and Environmental Policy*, **5**(2), pp. 101-112, 2003.